

## SOT-23 Plastic-Encapsulate MOSFET

### 20V P-Channel MOSFET

#### Product Summary

$V_{(BR)DSS}$	$R_{DS(on)TYP}$	$I_D$
-20V	70mΩ@-4.5V	-2.3A
	110mΩ@-2.5V	

#### Feature

- Trench Technology Power MOSFET
- Low  $R_{DS(ON)}$
- Low Gate Charge
- Low Gate Resistance

#### Application

- DC/DC Converter
- Load Switch

#### MARKING:

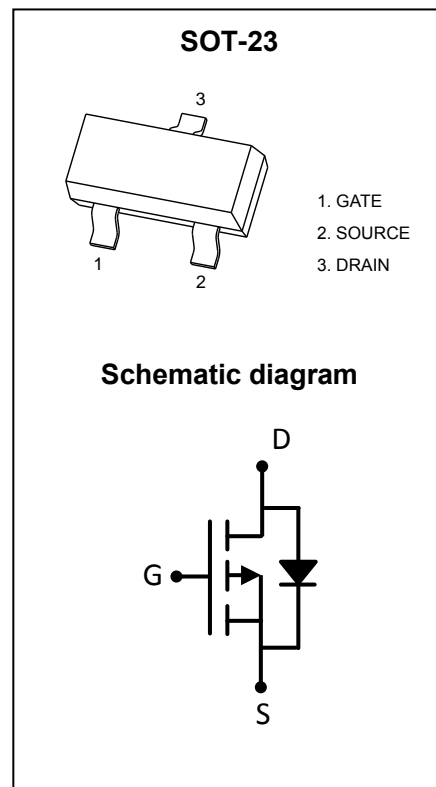
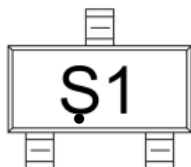

#### ABSOLUTE MAXIMUM RATINGS ( $T_A = 25^\circ\text{C}$ unless otherwise noted)

Parameter	Symbol	Value	Unit
Drain - Source Voltage	$V_{DS}$	-20	V
Gate - Source Voltage	$V_{GS}$	$\pm 10$	V
Continuous Drain Current <sup>1,5</sup>	$I_D$	-2.3	A
Pulsed Drain Current <sup>2</sup>	$I_{DM}$	-9.2	A
Power Dissipation <sup>4,5</sup>	$P_D$	0.75	W
Thermal Resistance from Junction to Ambient <sup>5</sup>	$R_{\theta JA}$	167	$^\circ\text{C}/\text{W}$
Junction Temperature	$T_J$	150	$^\circ\text{C}$
Storage Temperature	$T_{STG}$	-55~ +150	$^\circ\text{C}$

## Electrical Characteristics ( $T_A=25^\circ\text{C}$ unless otherwise noted)

Parameter	Symbol	Test Condition	Min	Type	Max	Unit
<b>Off Characteristics</b>						
Drain - Source Breakdown Voltage	$V_{(BR)DSS}$	$V_{GS} = 0V, I_D = -250\mu A$	-20			V
Zero Gate Voltage Drain Current	$I_{DSS}$	$V_{DS} = -20V, V_{GS} = 0V$			-1	$\mu A$
Gate - Body Leakage Current	$I_{GSS}$	$V_{GS} = \pm 10V, V_{DS} = 0V$			$\pm 100$	nA
<b>On Characteristics<sup>3</sup></b>						
Gate Threshold Voltage	$V_{GS(th)}$	$V_{DS} = V_{GS}, I_D = -250\mu A$	-0.4	-0.7	-1.0	V
Drain-source On-resistance	$R_{DS(on)}$	$V_{GS} = -4.5V, I_D = -3.0A$		70	112	m $\Omega$
		$V_{GS} = -2.5V, I_D = -2.0A$		110	142	
Forward Transconductance	$g_{FS}$	$V_{DS} = -5V, I_D = -2.0A$	3			S
<b>Dynamic Characteristics</b>						
Input Capacitance	$C_{iss}$	$V_{DS} = -10V, V_{GS} = 0V, f = 1MHz$		437		pF
Output Capacitance	$C_{oss}$			52		
Reverse Transfer Capacitance	$C_{rss}$			45		
<b>Switching Characteristics</b>						
Total Gate Charge	$Q_g$	$V_{DS} = -10V, V_{GS} = -4.5V, I_D = -3A$		4.87		nC
Gate-source Charge	$Q_{gs}$			0.99		
Gate-drain Charge	$Q_{gd}$			1.01		
Turn-on Delay Time	$t_{d(on)}$	$V_{DD} = -10V, V_{GS} = -4.5V,$ $R_L = 10\Omega, R_G = 3\Omega$		12		ns
Turn-on Rise Time	$t_r$			36		
Turn-off Delay Time	$t_{d(off)}$			32		
Turn-off Fall Time	$t_f$			9		
<b>Source - Drain Diode Characteristics</b>						
Diode Forward Voltage <sup>3</sup>	$V_{SD}$	$V_{GS} = 0V, I_S = -1.3A$			-1.2	V

Notes :

- 1.The maximum current rating is limited by package.
- 2.Pulse Test : Pulse Width  $\leq 10\mu s$ , duty cycle  $\leq 1\%$ .
- 3.Pulse Test : Pulse Width  $\leq 300\mu s$ , duty cycle  $\leq 2\%$ .
- 4.The power dissipation  $P_D$  is limited by  $T_{J(MAX)} = 150^\circ\text{C}$ .
- 5.Device mounted on  $1\text{in}^2$  FR-4 board with 2oz. Copper, in a still air environment with  $T_A = 25^\circ\text{C}$ .

# Typical Characteristics

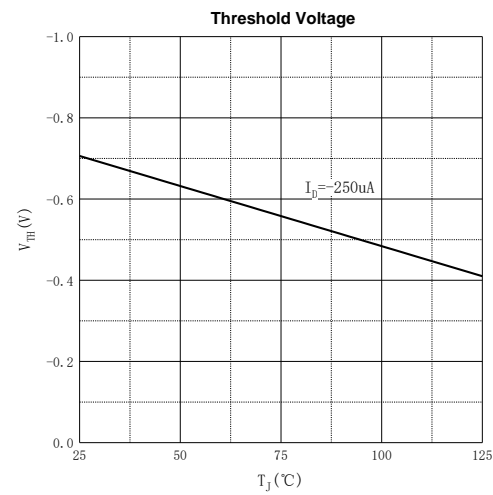
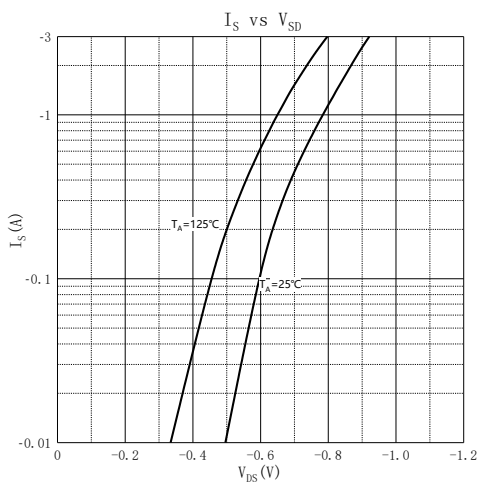
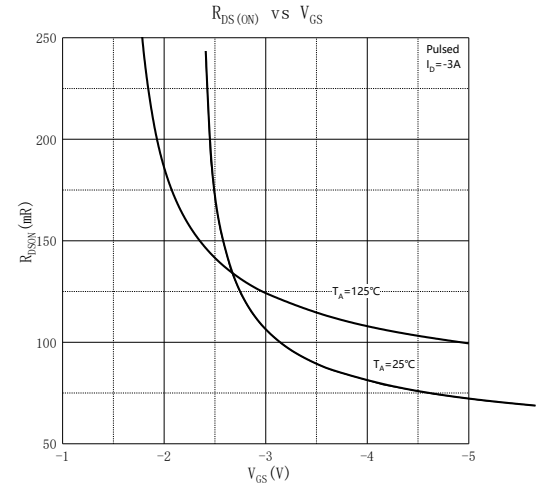
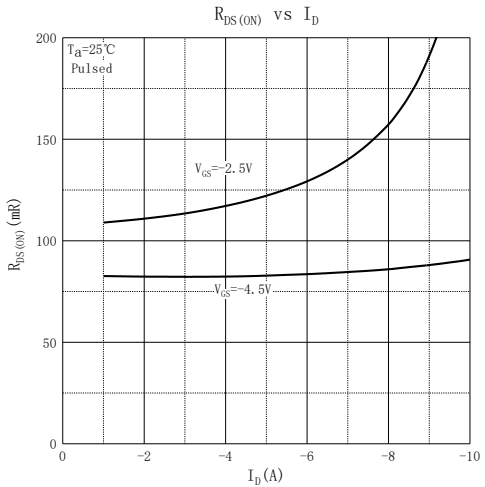
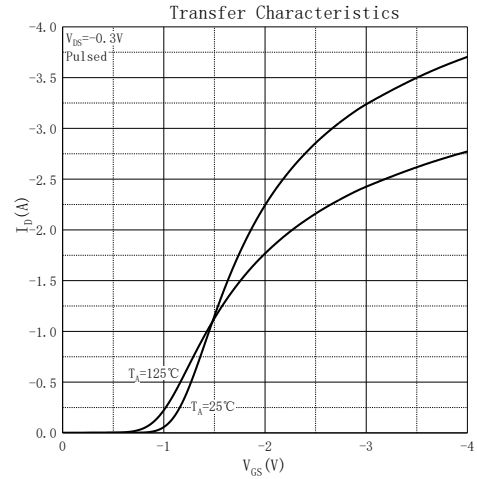
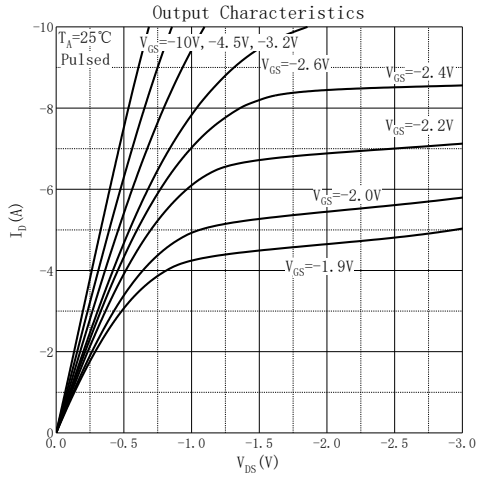

## SOT-23 Package Outline Dimensions

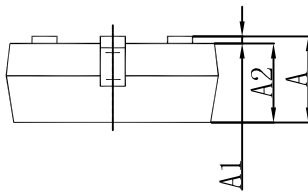
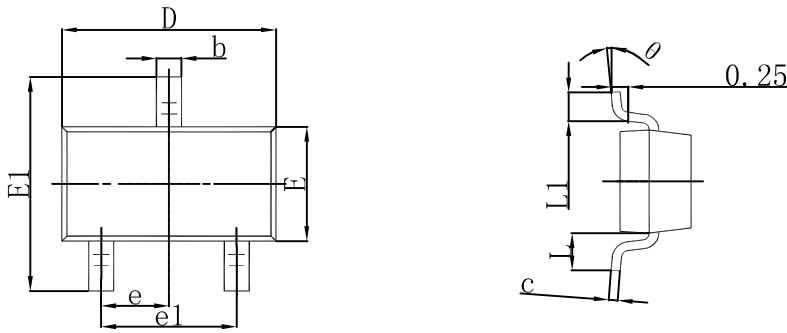

Symbol	Dimensions In Millimeters		Dimensions In Inches	
	Min	Max	Min	Max
A	0.900	1.150	0.035	0.045
A1	0.000	0.100	0.000	0.004
A2	0.900	1.050	0.035	0.041
b	0.300	0.500	0.012	0.020
c	0.080	0.150	0.003	0.006
D	2.800	3.000	0.110	0.118
E	1.150	1.500	0.045	0.059
E1	2.250	2.650	0.089	0.104
e	0.950 TYP		0.037 TYP	
e1	1.800	2.000	0.071	0.079
L	0.550 REF		0.022 REF	
L1	0.300	0.500	0.012	0.020
θ	0°	8°	0°	8°

## SOT-23 Suggested Pad Layout

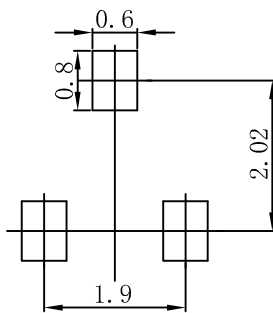

### Note:

1. Controlling dimension: in millimeters.
2. General tolerance:  $\pm 0.05\text{mm}$ .
3. The pad layout is for reference purposes only.

### NOTICE

JSJD reserve the right to make modifications, enhancements, improvements, corrections or other changes without further notice to any product herein. JSJD does not assume any liability arising out of the application or use of any product described herein.

# Reel Taping Specifications For Surface Mount Devices-SOT-23

## SOT-23 Embossed Carrier Tape

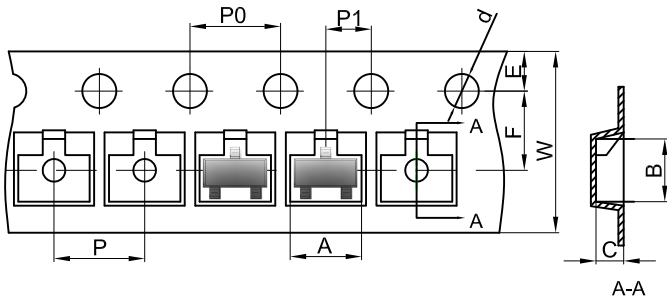

### Packaging Description:

SOT-23 parts are shipped in tape. The carrier tape is made from a dissipative (carbon filled) polycarbonate resin. The cover tape is a multilayer film (Heat Activated Adhesive in nature) primarily composed of polyester film, adhesive layer, sealant, and anti-static sprayed agent. These reeled parts in standard option are shipped with 3,000 units per 7" or 17.8cm diameter reel. The reels are clear in color and is made of polystyrene plastic (anti-static coated).

Dimensions are in millimeter

Pkg type	A	B	C	d	E	F	P0	P	P1	W
SOT-23	3.15	2.77	1.22	Ø1.50	1.75	3.50	4.00	4.00	2.00	8.00

## SOT-23 Tape Leader and Trailer

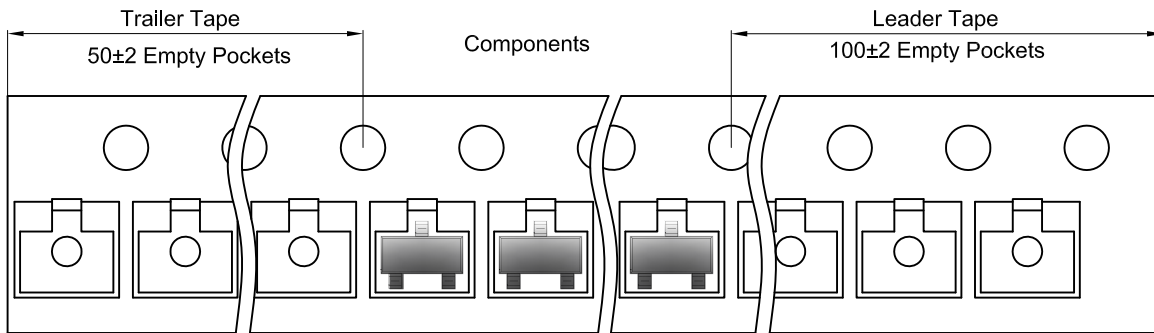

## SOT-23 Reel

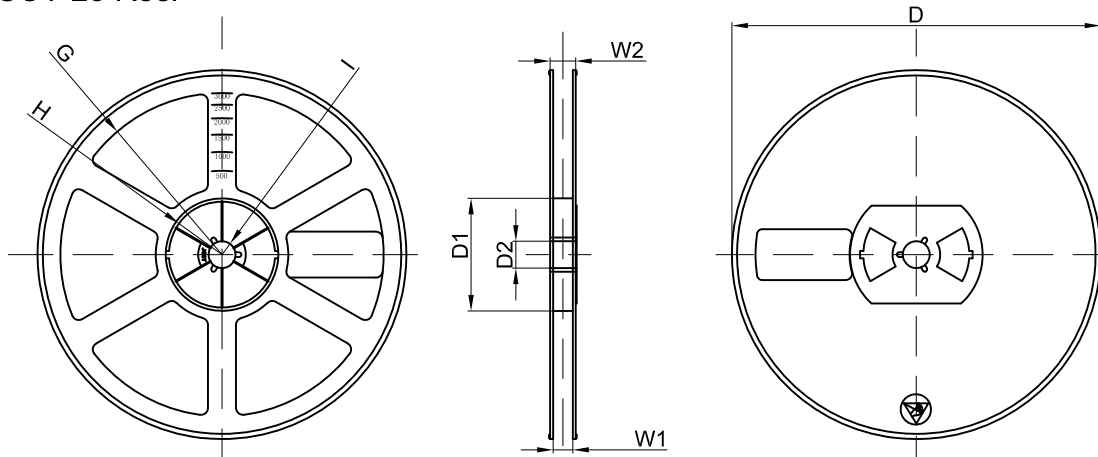

Dimensions are in millimeter

Reel Option	D	D1	D2	G	H	I	W1	W2
7"Dia	Ø178.00	54.40	13.00	R78.00	R25.60	R6.50	9.50	12.30

REEL	Reel Size	Box	Box Size(mm)	Carton	Carton Size(mm)	G.W.(kg)
3000 pcs	7 inch	45,000 pcs	203×203×195	180,000 pcs	438×438×230	