

## SMCG Plastic-Encapsulate Diodes

### Transient Voltage Suppressor Diodes

#### Features

- $P_{PPM}$  1500W
- $V_{RWM}$  5.0V- 440V
- Low power loss, high efficiency
- Excellent clamping capability

#### Applications

- Protect sensitive circuit from damage by high voltage transients
- Lighting, ESD transient voltage protection of IC, system
- Inductive switching load protection of IC, system
- Electrical Fast Transient Immunity protection of IC, system

#### Mechanical Data

- Case: JEDEC DO-214AB molded plastic
- Molding compound: UL flammability classification rating 94V-0
- Terminals: Solder plated, solderable per MIL- STD-202, Method 208
- Polarity: Color band denotes cathode end

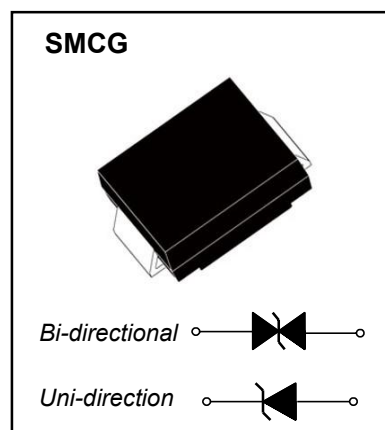

#### Limiting Values (Absolute Maximum Rating)

Item	Symbol	Unit	Conditions	Max
Peak pulse power dissipation	$P_{PPM}$	W	with a 10/1000us waveform	1500
Peak pulse current (1)	$I_{PPM}$	A	with a 10/1000us waveform	See Next Table
Power dissipation	$P_D$	W	On infinite heat sink at $T_L=75^\circ\text{C}$	6.5
Peak forward surge current	$I_{FSM}$	A	8.3 ms single half sine-wave unidirectional only	200
Operating junction and storage temperature range	$T_J, T_{STG}$	$^\circ\text{C}$		-55 to +150

#### Electrical Characteristics ( $T_A=25^\circ\text{C}$ Unless otherwise specified)

Item	Symbol	Unit	Conditions	Max
Maximum instantaneous forward Voltage (2)	$V_F$	V	at 100A for unidirectional only	3.5/5.0
Thermal resistance	$R_{\theta JL}$	$^\circ\text{C}/\text{W}$	Between junction and lead	15
	$R_{\theta JA}$	$^\circ\text{C}/\text{W}$	Between junction and Ambient	75
	$R_{\theta JC}$	$^\circ\text{C}/\text{W}$	Between junction and Case	10

#### Notes:

- (1) Non-repetitive current pulse, per Fig. 3 and derated above  $T_A = 25^\circ\text{C}$  per Fig.2.
- (2)  $V_F < 3.5\text{V}$  for devices of  $V_{BR} < 200\text{V}$  and  $V_F < 5.0\text{V}$  for devices of  $V_{BR} > 201\text{V}$

## Electrical Characteristics (T<sub>A</sub>=25°C unless otherwise noted)

Part Number (Uni)	Part Number (Bi)	V <sub>BR</sub> @I <sub>T</sub> Breakdown Voltage V <sub>BR</sub> @I <sub>T</sub>			I <sub>R</sub> @V <sub>WM</sub> Maximum Reverse Leakage I <sub>R</sub> <sup>(3)</sup> (μA)	V <sub>RWM</sub> Working Peak Reverse Voltage V <sub>RWM</sub> (V)	IPP Maximum Reverse Surge Current IPP <sup>(2)</sup> (A)	Maximum Clamping Voltage V <sub>c</sub> @ I <sub>PP</sub> (V)
		Min(V)	Max (V)	IT <sup>(1)</sup> (mA)				
SMCJ5.0A	SMCJ5.0CA <sup>(4)</sup>	6.40	7.07	10.0	1000	5.0	163.0	9.2
SMCJ6.0A	SMCJ6.0CA	6.67	7.37	10.0	1000	6.0	145.6	10.3
SMCJ6.5A	SMCJ6.5CA	7.22	7.98	10.0	500	6.5	133.9	11.2
SMCJ7.0A	SMCJ7.0CA	7.78	8.60	10.0	200	7.0	125.0	12.0
SMCJ7.5A	SMCJ7.5CA	8.33	9.21	1.0	100	7.5	116.3	12.9
SMCJ8.0A	SMCJ8.0CA	8.89	9.83	1.0	50	8.0	110.3	13.6
SMCJ8.5A	SMCJ8.5CA	9.44	10.40	1.0	20	8.5	104.2	14.4
SMCJ9.0A	SMCJ9.0CA	10.00	11.10	1.0	10	9.0	97.4	15.4
SMCJ10A	SMCJ10CA	11.10	12.30	1.0	5	10.0	88.2	17.0
SMCJ11A	SMCJ11CA	12.20	13.50	1.0	5	11.0	82.4	18.2
SMCJ12A	SMCJ12CA	13.30	14.70	1.0	5	12.0	75.4	19.9
SMCJ13A	SMCJ13CA	14.40	15.90	1.0	5	13.0	69.8	21.5
SMCJ14A	SMCJ14CA	15.60	17.20	1.0	5	14.0	64.7	23.2
SMCJ15A	SMCJ15CA	16.70	18.50	1.0	5	15.0	61.5	24.4
SMCJ16A	SMCJ16CA	17.80	19.70	1.0	5	16.0	57.7	26.0
SMCJ17A	SMCJ17CA	18.90	20.90	1.0	5	17.0	54.3	27.6
SMCJ18A	SMCJ18CA	20.00	22.10	1.0	5	18.0	51.4	29.2
SMCJ19A	SMCJ19CA	21.10	23.30	1.0	5	19.0	48.7	30.8
SMCJ20A	SMCJ20CA	22.20	24.50	1.0	5	20.0	46.3	32.4
SMCJ22A	SMCJ22CA	24.40	26.90	1.0	5	22.0	42.3	35.5
SMCJ24A	SMCJ24CA	26.70	29.50	1.0	5	24.0	38.6	38.9
SMCJ26A	SMCJ26CA	28.90	31.90	1.0	5	26.0	35.6	42.1
SMCJ28A	SMCJ28CA	31.10	34.40	1.0	5	28.0	33.0	45.4
SMCJ30A	SMCJ30CA	33.30	36.80	1.0	5	30.0	31.0	48.4
SMCJ33A	SMCJ33CA	36.70	40.60	1.0	5	33.0	28.1	53.3
SMCJ36A	SMCJ36CA	40.00	44.20	1.0	5	36.0	25.8	58.1
SMCJ40A	SMCJ40CA	44.40	49.10	1.0	5	40.0	23.3	64.5
SMCJ43A	SMCJ43CA	47.80	52.80	1.0	5	43.0	21.6	69.4
SMCJ45A	SMCJ45CA	50.00	55.30	1.0	5	45.0	20.6	72.7
SMCJ48A	SMCJ48CA	53.30	58.90	1.0	5	48.0	19.4	77.4
SMCJ51A	SMCJ51CA	56.70	62.70	1.0	5	51.0	18.2	82.4
SMCJ54A	SMCJ54CA	60.00	66.30	1.0	5	54.0	17.2	87.1
SMCJ58A	SMCJ58CA	64.40	71.20	1.0	5	58.0	16.0	93.6
SMCJ60A	SMCJ60CA	66.70	73.70	1.0	5	60.0	15.5	96.8
SMCJ64A	SMCJ64CA	71.10	78.60	1.0	5	64.0	14.5	103.0
SMCJ70A	SMCJ70CA	77.80	86.00	1.0	5	70.0	13.3	113.0
SMCJ75A	SMCJ75CA	83.30	92.10	1.0	5	75.0	12.4	121.0
SMCJ78A	SMCJ78CA	86.70	95.80	1.0	5	78.0	11.9	126.0
SMCJ80A	SMCJ80CA	88.80	97.60	1.0	5	80.0	11.6	129.6

## Electrical Characteristics ( $T_A=25^\circ\text{C}$ unless otherwise noted)

Part Number (Uni)	Part Number (Bi)	$V_{BR}@I_T$ Breakdown Voltage $V_{BR}@I_T$			$I_R@V_{WM}$ Maximum Reverse Leakage $I_R^{(3)}$ ( $\mu\text{A}$ )	$V_{RWM}$ Working Peak Reverse Voltage $V_{RWM}$ (V)	IPP Maximum Reverse Surge Current IPP <sup>(2)</sup> (A)	Maximum Clamping Voltage $V_c$ @ $I_{PP}$ (V)
		Min(V)	Max (V)	$I_T^{(1)}$ (mA)				
SMCJ85A	SMCJ85CA	94.40	104.00	1.0	5	85.0	10.9	137.0
SMCJ90A	SMCJ90CA	100.00	111.00	1.0	5	90.0	10.3	146.0
SMCJ100A	SMCJ100CA	111.00	123.00	1.0	5	100.0	9.3	162.0
SMCJ110A	SMCJ110CA	122.00	135.00	1.0	5	110.0	8.5	177.0
SMCJ120A	SMCJ120CA	133.00	147.00	1.0	5	120.0	7.8	193.0
SMCJ130A	SMCJ130CA	144.00	159.00	1.0	5	130.0	7.2	209.0
SMCJ140A	SMCJ140CA	155.00	171.00	1.0	5	140.0	6.6	226.8
SMCJ150A	SMCJ150CA	167.00	185.00	1.0	5	150.0	6.2	243.0
SMCJ160A	SMCJ160CA	178.00	197.00	1.0	5	160.0	5.8	259.0
SMCJ170A	SMCJ170CA	189.00	209.00	1.0	5	170.0	5.4	275.0
SMCJ180A	SMCJ180CA	200.00	220.00	1.0	5	180.0	5.1	291.6
SMCJ190A	SMCJ190CA	211.00	232.00	1.0	5	190.0	4.8	307.8
SMCJ200A	SMCJ200CA	224.00	247.00	1.0	5	200.0	4.6	324.0
SMCJ220A	SMCJ220CA	246.00	272.00	1.0	5	220.0	4.2	356.0
SMCJ250A	SMCJ250CA	279.00	309.00	1.0	5	250.0	3.7	405.0
SMCJ300A	SMCJ300CA	335.00	371.00	1.0	5	300.0	3.1	486.0
SMCJ350A	SMCJ350CA	391.00	432.00	1.0	5	350.0	2.6	567.0
SMCJ400A	SMCJ400CA	447.00	494.00	1.0	5	400.0	2.3	648.0
SMCJ440A	SMCJ440CA	492.00	543.00	1.0	5	440.0	2.1	713.0

### Notes:

- (1)  $t_p \leq 50\text{ms}$  Pulse test:  $t_p \leq 50\text{ms}$
- (2) Surge current waveform per Fig. 3 and derated per Fig.2.
- (3) For bi-directional types having  $V_{WM}$  of 10 V and less, the  $I_R$  limit is doubled
- (4) For the bi-directional SMCJ5.0CA, the maximum  $V_{BR}$  is 7.25V

# Typical Characteristics

FIG1: Peak Pulse Power Rating Curve

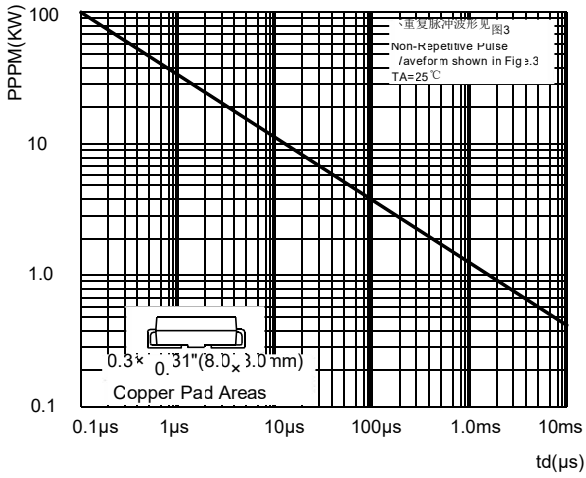

FIG2: Pulse Power or Current vs. Initial Junction Temperature

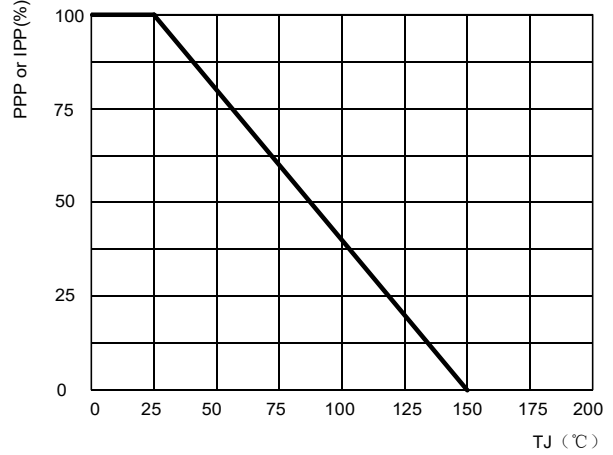

FIG3: Pulse Waveform

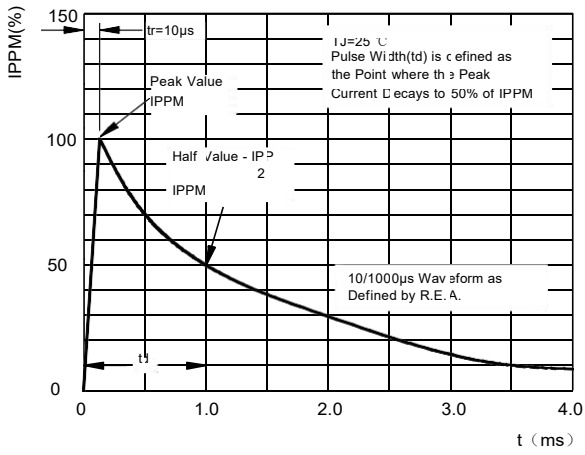

FIG4: Typical Transient Thermal Impedance

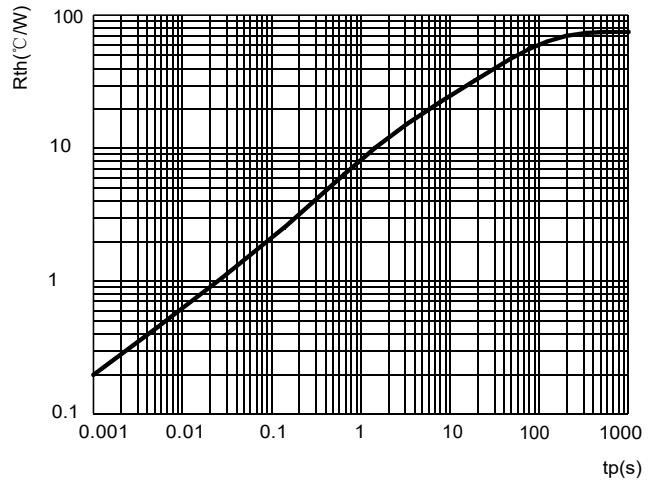

FIG5: Maximum Non-Repulsive Surge Current

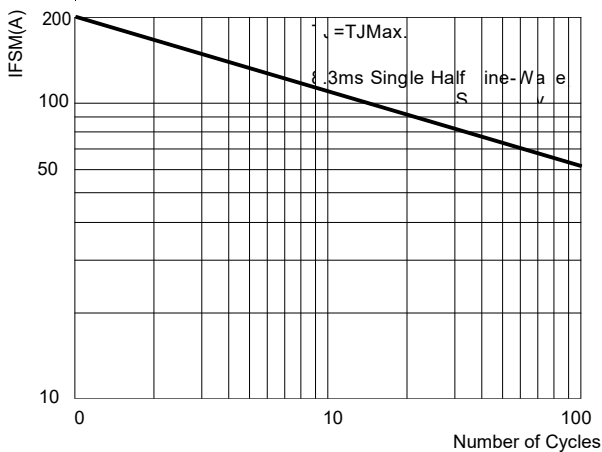
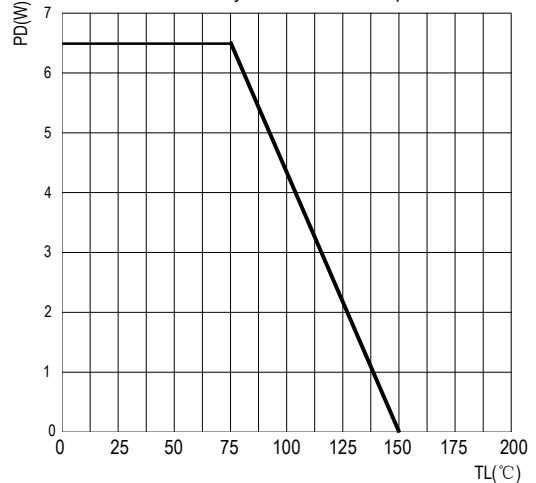
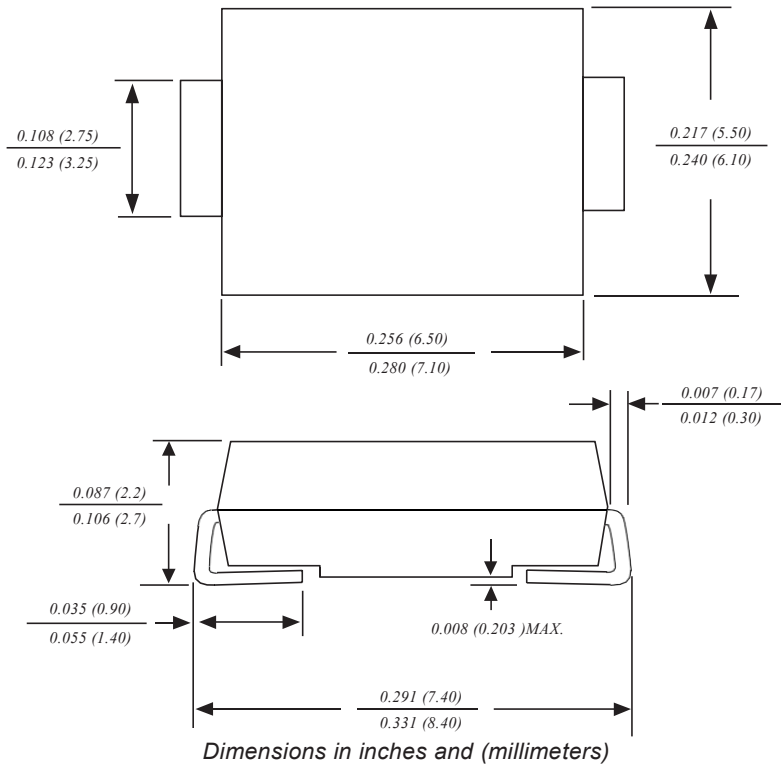

FIG6: Steady State Power Dissipation



## SMCG Package Outline Dimensions



## SMCG Suggested Pad Layout

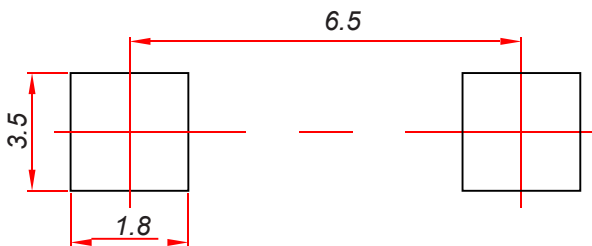

### Note:

1. Controlling dimension: in millimeters.
2. General tolerance:  $\pm 0.05\text{mm}$ .
3. The pad layout is for reference purposes only.

## Ordering Information

Part Number	Package	Shipping Quantity
SMCJ5.0(C)A- SMCJ440(C)A	SMCG	3000/tape&Reel

## Marking Diagram

Uni-direction



XX: From 5.0 To 440

Bi-directional



# Reel Taping Specifications For Surface Mount Devices – SMCG

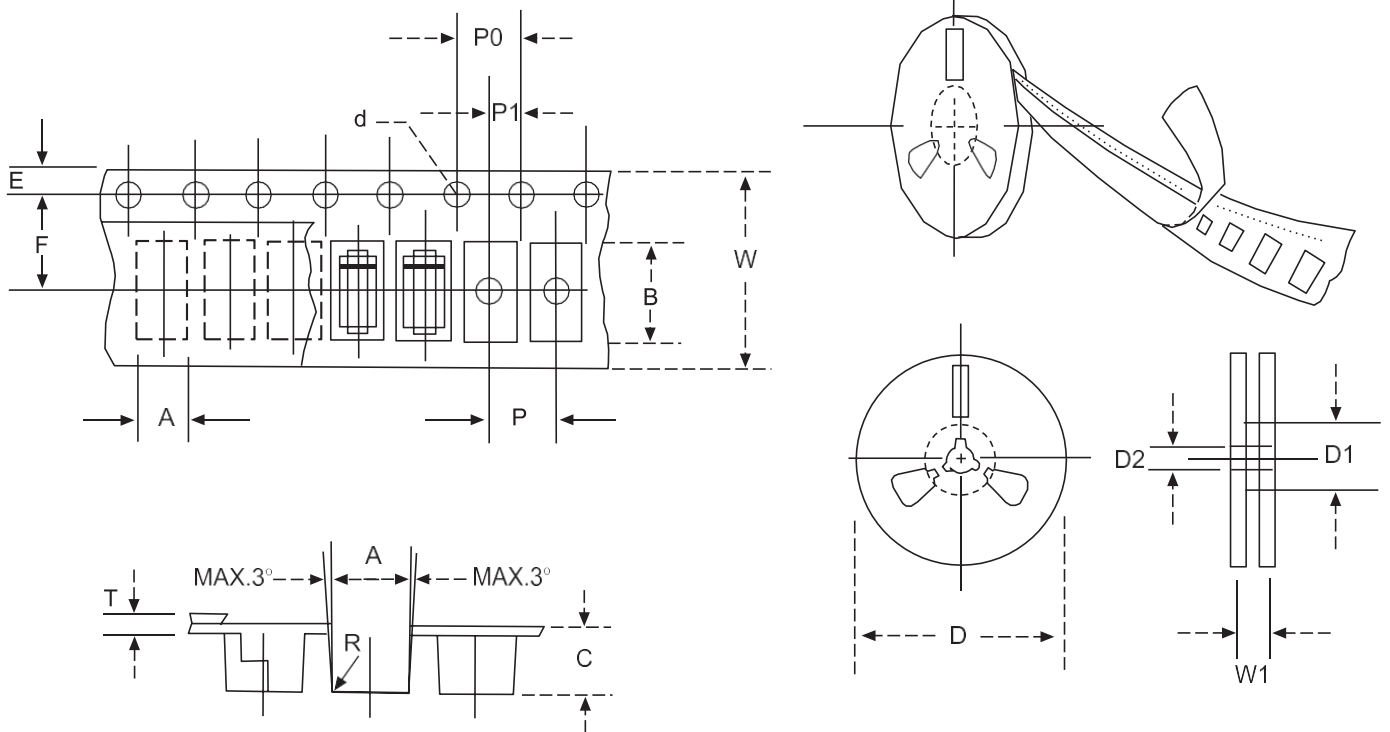

**FIG: CONFIGURATION OF SURFACE MOUNTED DEVICES TAPING**

ITEM	SYMBOL	SMCG mm(inch)
Carrier width	A	6.05±0.1(0.238±0.004)
Carrier length	B	8.31±0.1(0.327±0.004)
Carrier depth	C	2.70±0.1(0.106±0.004)
Sprocket hole	d	1.55±0.05(0.061±0.002)
Reel outside diameter	D	330±2.0(13±0.079)
Reel inner diameter	D1	75 ±1.0 ( 2.95 ±0.039 )
Feed hole diameter	D2	13±0.5(0.512±0.020)
Sprocket hole position	E	1.75±0.1(0.069±0.004)
Punch hole position	F	7.65±0.05(0.301±0.002)
Punch hole pitch	P	8.0±0.1(0.315±0.004)
Sprocket hole pitch	P0	4.0±0.1(0.157±0.004)
Embossment center	P1	2.0±0.1(0.079±0.004)
Total tape thickness	T	0.3±0.1(0.012±0.004)
Tape width	W	16.0±0.2(0.630±0.008)
Reel width	W1	24.0±2.0(0.945±0.079)

NOTE: Devices are packed in accordance with EIA standard RS-481-A and specification given above.