

SOD-123FL Plastic-Encapsulate Diodes

Transient Voltage Suppressor Diodes

Features

- P_{PPM} 200W
- V_{RWM} 5.0V- 440V
- Low power loss, high efficiency
- Excellent clamping capability

Applications

- Protect sensitive circuit from damage by high voltage transients
- Lighting, ESD transient voltage protection of IC, system
- Inductive switching load protection of IC, system
- Electrical Fast Transient Immunity protection of IC, system

Mechanical Data

- Case: SOD-123FL molded plastic
- Molding compound: UL flammability classification rating 94V-0
- Terminals: Solder plated, solderable per MIL- STD-202, Method 208
- Polarity: Color band denotes cathode end

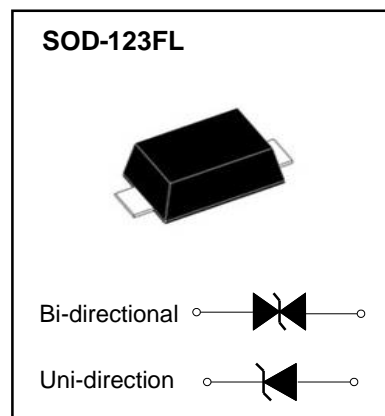

Limiting Values (Absolute Maximum Rating)

Item	Symbol	Unit	Conditions	Max
Peak power dissipation	P_{PPM}	W	with a 10/1000us waveform ⁽¹⁾	200
Peak pulse current	I_{PPM}	A	with a 10/1000us waveform	See Next Table
Surge(Non-repetitive)Forward Current	I_{FSM}	A	Peak forward surge current, 8.3 ms single half sinewave unidirectional only	30
Peak Forward Voltage	V_F	V	Maximum instantaneous forward voltage at 10 A for unidirectional only ⁽²⁾	3.5/6.5
Operating junction and storage temperature range	T_J, T_{STG}	°C		-55 to +150
Thermal resistance	$R_{\theta JL}$	°C/W	Between junction and lead	26
	$R_{\theta JA}$	°C/W	Between junction and Ambient	300
	$R_{\theta JC}$	°C/W	Between junction and Case	40

Notes:

(1) Non-repetitive current pulse at $T_A=25^{\circ}\text{C}$, per waveform of Figure 4.

(2) $V_F < 3.5\text{V}$ for devices of $V_{BR} < 200\text{V}$ and $V_F < 6.5\text{V}$ for devices of $V_{BR} > 201\text{V}$.

Electrical Characteristics (T_A=25°C unless otherwise noted)

Part Number		Reverse Stand off Voltage	Breakdown Voltage V _{BR} @I _T		Test Current	Max Clamping Voltage@I _{pp}	Max Peak Pulse Current	Max Reverse Leakage@V _{RWM}
UNI-POLAR	BI-POLAR	V _{RWM} (V)	Min.(V)	Max.(V)	I _T (mA)	V _C MAX.(V)	I _{pp} (A)	I _R (uA)
SMF5.0A	SMF5.0CA	5.0	6.40	7.00	10	9.2	21.7	800
SMF6.0A	SMF6.0CA	6.0	6.67	7.37	10	10.3	19.4	800
SMF6.5A	SMF6.5CA	6.5	7.22	7.98	10	11.2	17.8	500
SMF7.0A	SMF7.0CA	7.0	7.78	8.60	10	12	16.6	200
SMF7.5A	SMF7.5CA	7.5	8.33	9.21	1	12.9	15.5	100
SMF8.0A	SMF8.0CA	8.0	8.89	9.83	1	13.6	14.7	50
SMF8.5A	SMF8.5CA	8.5	9.44	10.40	1	14.4	13.8	20
SMF9.0A	SMF9.0CA	9.0	10.00	11.10	1	15.4	13	10
SMF10A	SMF10CA	10.0	11.10	12.30	1	17	11.7	5
SMF11A	SMF11CA	11.0	12.20	13.50	1	18.2	11	1
SMF12A	SMF12CA	12.0	13.30	14.70	1	19.9	10	1
SMF13A	SMF13CA	13.0	14.40	15.90	1	21.5	9.3	1
SMF14A	SMF14CA	14.0	15.60	17.20	1	23.2	8.6	1
SMF15A	SMF15CA	15.0	16.70	18.50	1	24.4	8.2	1
SMF16A	SMF16CA	16.0	17.80	19.70	1	26	7.7	1
SMF17A	SMF17CA	17.0	18.90	20.90	1	27.6	7.2	1
SMF18A	SMF18CA	18.0	20.00	22.10	1	29.2	6.8	1
SMF20A	SMF20CA	20.0	22.00	24.50	1	32.4	6.1	1
SMF22A	SMF22CA	22.0	24.40	26.90	1	35.5	5.6	1
SMF24A	SMF24CA	24.0	26.70	29.50	1	38.9	5.1	1
SMF26A	SMF26CA	26.0	28.90	31.90	1	42.1	4.7	1
SMF28A	SMF28CA	28.0	31.10	34.40	1	45.4	4.4	1
SMF30A	SMF30CA	30.0	33.50	36.80	1	48.4	4.1	1
SMF33A	SMF33CA	33.0	36.70	40.60	1	53.3	3.7	1
SMF36A	SMF36CA	36.0	40.00	44.20	1	58.1	3.4	1
SMF40A	SMF40CA	40.0	44.40	49.10	1	64.5	3.1	1
SMF43A	SMF43CA	43.0	47.80	52.80	1	69.4	2.9	1
SMF45A	SMF45CA	45.0	50.00	55.30	1	72.7	2.7	1
SMF48A	SMF48CA	48.0	53.30	58.90	1	77.4	2.6	1
SMF51A	SMF51CA	51.0	56.70	62.70	1	82.4	2.4	1
SMF54A	SMF54CA	54.0	60.00	66.30	1	87.1	2.3	1
SMF58A	SMF58CA	58.0	64.40	71.20	1	93.6	2.1	1
SMF60A	SMF60CA	60.0	66.70	73.70	1	96.8	2	1
SMF64A	SMF64CA	64.0	71.10	78.60	1	103.0	1.9	1
SMF70A	SMF70CA	70.0	77.80	86.00	1	113.0	1.7	1
SMF75A	SMF75CA	75.0	83.30	92.10	1	121.0	1.6	1
SMF78A	SMF78CA	78.0	86.70	95.80	1	126.0	1.5	1
SMF85A	SMF85CA	85.0	94.4	104.0	1	137.0	1.4	1
SMF90A	SMF90CA	90.0	100.0	111.0	1	146.0	1.3	1
SMF100A	SMF100CA	100.0	111.0	123.0	1	162.0	1.2	1
SMF110A	SMF110CA	110.0	122.0	135.0	1	177.0	1.1	1
SMF120A	SMF120CA	120.0	133.0	147.0	1	193.0	1	1
SMF130A	SMF130CA	130.0	144.0	159.0	1	209.0	0.9	1
SMF150A	SMF150CA	150.0	167.0	185.0	1	243.0	0.8	1
SMF160A	SMF160CA	160.0	178.0	197.0	1	259.0	0.7	1
SMF170A	SMF170CA	170.0	189.0	209.0	1	275.0	0.7	1
SMF180A	SMF180CA	180.0	201.0	222.0	1	292.0	0.7	1
SMF190A	SMF190CA	190.0	209.0	243.0	1	308.0	0.6	1
SMF200A	SMF200CA	200.0	224.0	247.0	1	324.0	0.6	1
SMF210A	SMF210CA	210.0	231.0	268.0	1	340.0	0.6	1
SMF220A	SMF220CA	220.0	246.0	272.0	1	356.0	0.5	1
SMF250A		250.0	279.0	309.0	1	405.0	0.5	1
SMF300A		300.0	335.0	371.0	1	486.0	0.4	1
SMF350A		350.0	391.0	432.0	1	567.0	0.3	1
SMF400A		400.0	447.0	494.0	1	648.0	0.3	1
SMF440A		440.0	492.0	543.0	1	713.0	0.3	1

Typical Characteristics

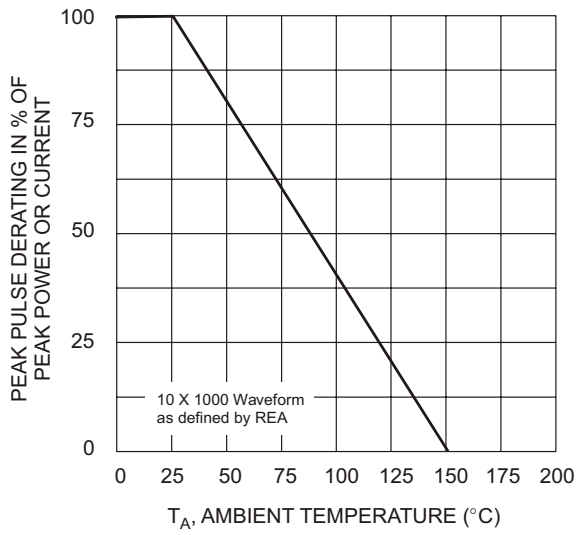

Fig. 1 Pulse Derating Curve

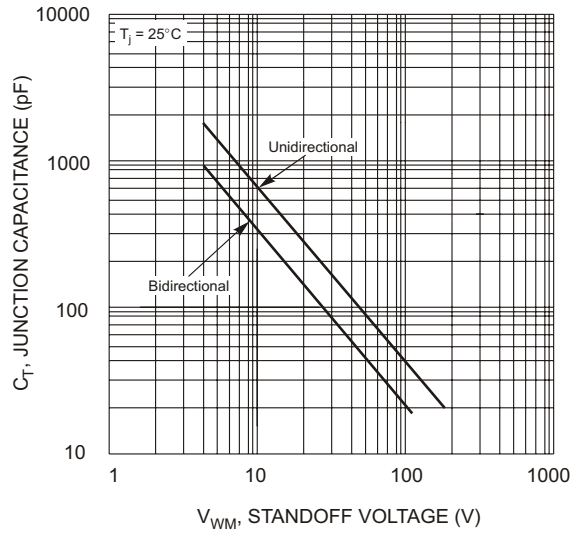

Fig. 2 Typical Total Capacitance

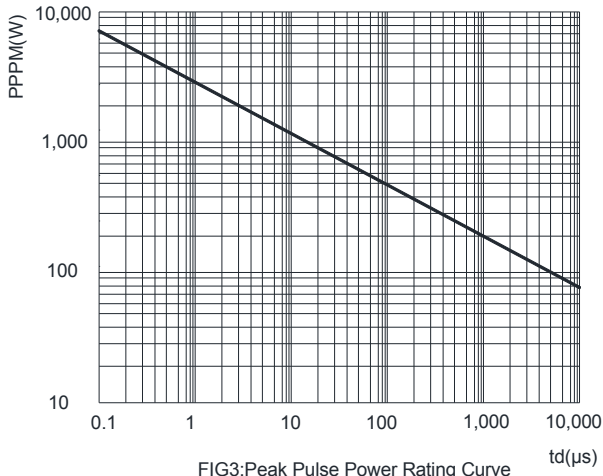

FIG3: Peak Pulse Power Rating Curve

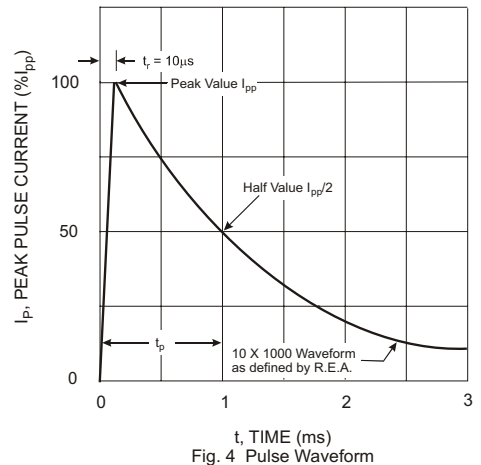

Fig. 4 Pulse Waveform

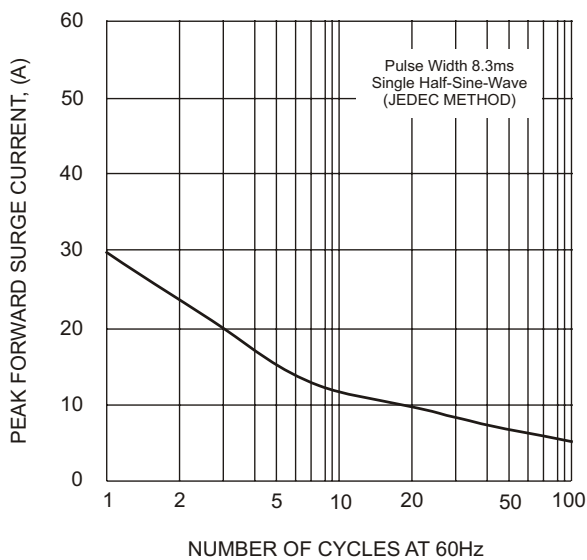

Fig. 5 Maximum Non-Repetitive Surge Current

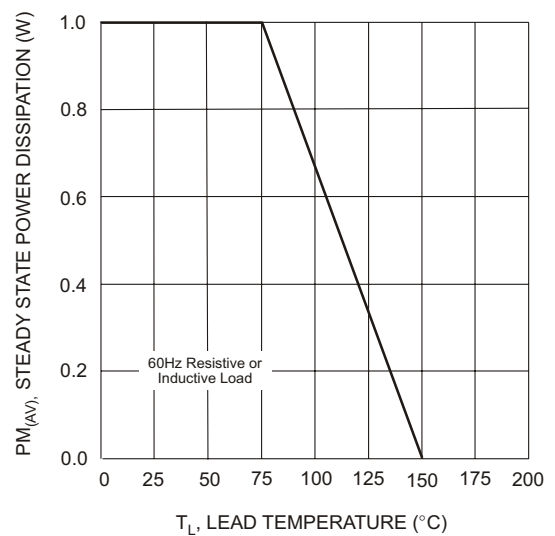
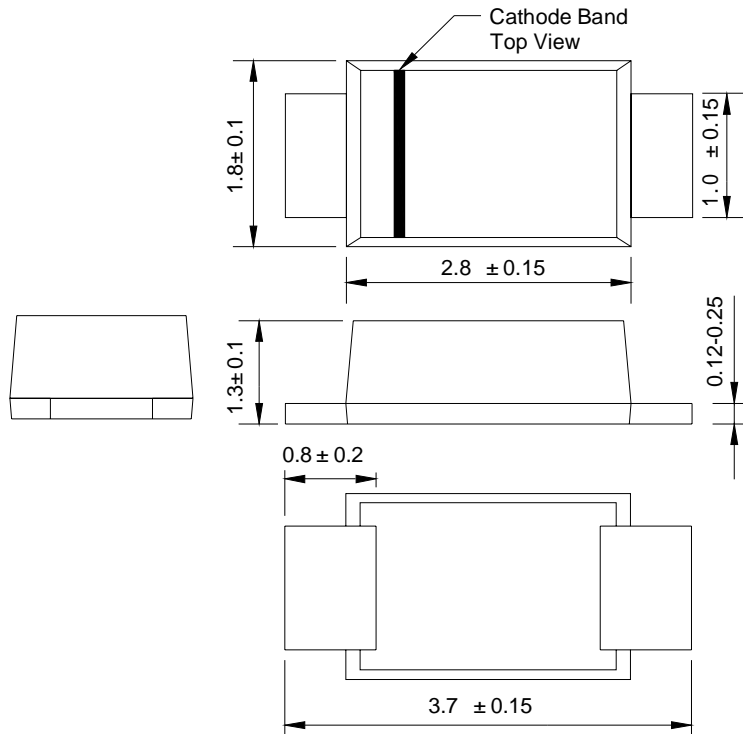

Fig. 6 Steady State Power Derating Curve

SOD-123FL Package Outline Dimensions



Dimensions in millimeters

SOD-123FL Suggested Pad Layout

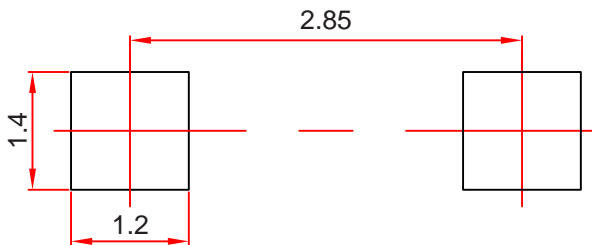

Note:

1. Controlling dimension: in millimeters.
2. General tolerance: ± 0.05 mm.
3. The pad layout is for reference purposes only.

Ordering Information

Part Number	Package	Shipping Quantity
SMF5.0(C)A- SMF440(C)A	SOD-123FL	3000/tape&Reel

Marking Diagram

Uni-direction



XX: From 5.0 To 440

Bi-directional



Reel Taping Specifications For Surface Mount Devices–SOD-123FL

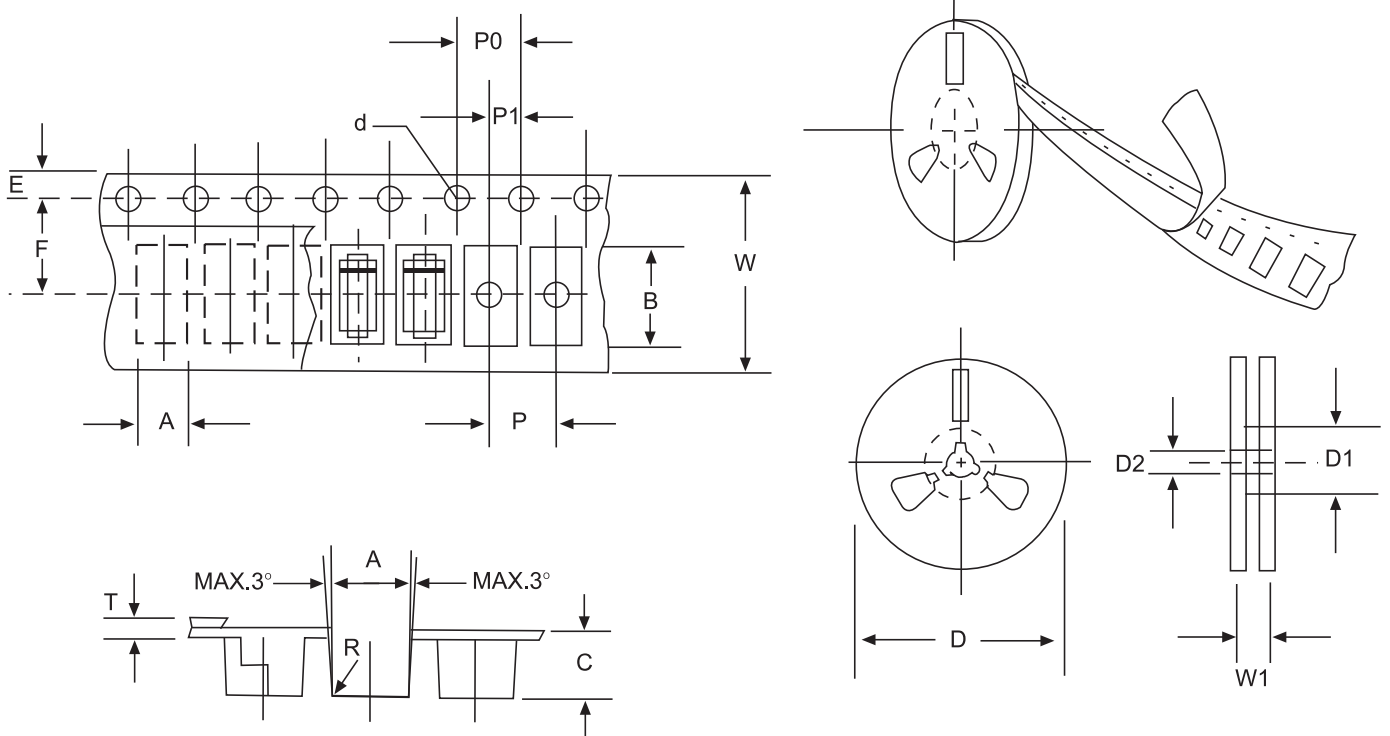

FIG : CONFIGURATION OF SURFACE MOUNTED DEVICES TAPING

ITEM	SYMBOL	SOD-123FLmm(inch)
Carrier width	A	2.05±0.1(0.081±0.004)
Carrier length	B	3.95±0.1(0.156±0.004)
Carrier depth	C	1.45±0.1(0.057±0.004)
Sprocket hole	d	1.55±0.05(0.061±0.002)
Reel outside diameter	D	178±2.0(7.0±0.079)
Reel inner diameter	D1	54±1.0(2.13±0.039)
Feed hole diameter	D2	13±0.5(0.512±0.020)
Sprocket hole position	E	1.75±0.1(0.069±0.004)
Punch hole position	F	3.50±0.1(0.138±0.002)
Punch hole pitch	P	4.0±0.1(0.157±0.004)
Sprocket hole pitch	P0	4.0±0.1(0.157±0.004)
Embossment center	P1	2.0±0.1(0.079±0.004)
Total tape thickness	T	0.21±0.25(0.008±0.010)
Tape width	W	8.0±0.2(0.315±0.008)
Reel width	W1	10.0±2.0(0.394±0.079)

NOTE: Devices are packed in accordance with EIA standard RS-481-A and specification given above.